

Article number: 0110079

Description: Retaining ring JS 65x3
Springsteel

Measures

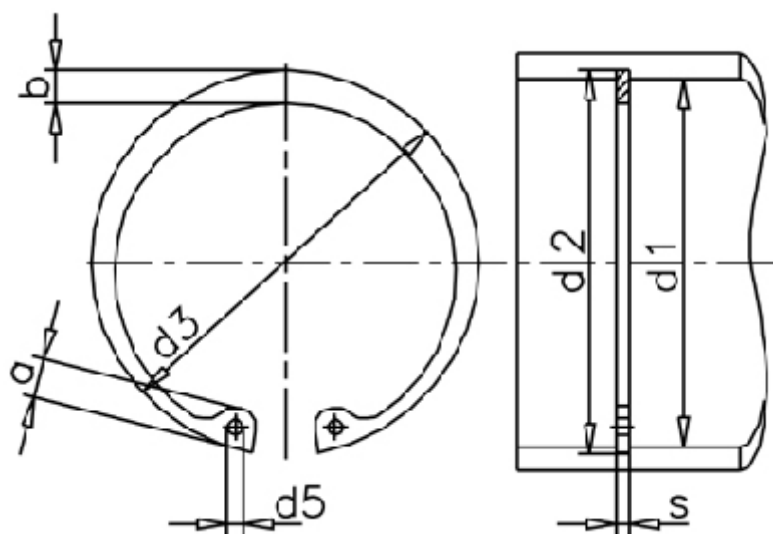

a max	= 8.7	Description	= JS 65	t	= 1.50
AN mm ²	= 313	FN kN	= 51.8	tol	= 0.30
B	= 1.44	FRg kN	= 30.0	tol	= +1,10 -0,46
b	= 5.8	FR kN	= 174.0	tol	= -0.08
d1	= 65	g	= 2.5	Tong	= ZGJ-3
d2	= 68.0	m min	= 3.15	Weight kg/1000	= 16.6
d3	= 69.2	Nominal drive	= 4.5		
d5 min	= 3.0	s	= 3.00		